

**7103C**  
NEW AGE



**RADIOCONTROL**

**7103C**

**Ferrari**

**PASSION FOR LIFTING**



# 7103C



**Break the boundaries  
in performance and  
safety**

**Link on column**  
Constant lifting capacity on all  
main boom positions

**Link on second boom**  
Boom negative angle allows  
access to confined spaces

**Extension Quick  
System and Smart  
Extension Sequence**  
Fast, precise, safe

**425° Slewing angle**  
The widest slewing angle for  
medium sized cranes

**Ergonomic control station  
and user-friendly interface**  
Comfortable, convenient and safe

**Always stable**  
More than 40 stabilizer  
combinations available

**Heavy duty hook  
attachment**  
Ruggedness and durability  
in all applications





**7" color display**  
Simple and quick access to all the functions and information

**Vertical stabilizer levers**  
Safe and fast. Excellent supervision of stabilizing operation

**Ergonomic control station engineered for maximum operator comfort and ease of operation**



**Dynamic Load Diagram**



- Improved efficiency
- Easy to use
- Optimised safety

**Crane lifting capacity always under control in all stabilizer positions.**

After the truck has been stabilized, the operator selects the load weight to be lifted. The display shows the permitted crane outreach based on the truck stability and load selected.

**Magic Touch**



- Easy to start and close
- Save time
- Increased productivity and safety

**Crane Automatic folding/unfolding.**

This system allows the operator to unfold the crane to a working position and fold the crane from any position to transport position by pressing a single button on the radio transmitter or display.

**Crane control system**

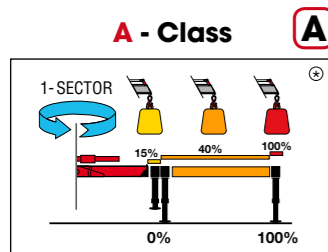

- N. 2 step stabilizer beams
- N. 1 sector on slewing
- Mono-area pressure limit

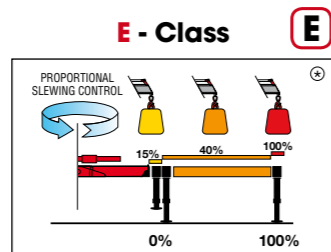

- N. 2 step stabilizer beams
- Proportional slewing control
- Truck side independent

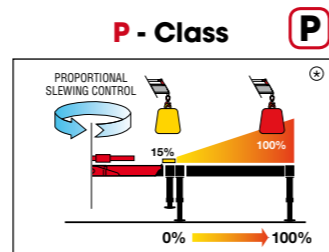

- Proportional stabilizers control
- Proportional slewing control
- Truck side independent

Ⓢ The percentages present in the pictures are merely examples and they have no bearing on the cranes' real lifting capacities. The cranes' real lifting capacity will depend on truck's stability.

**Human machine interface**

**Bright Led panel** **L**

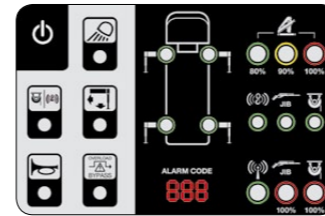

Available for the entire range till 28 tm. Highly user-friendly design, with buttons and LED lights. Dedicated led lights to identify the position of each stabilizer. New 3-digits display has been added to inform the operator about alarms and errors.

**Intelligent Display 4.3" D**



Up to 6 languages available. Full color new display. Offers more information and data compared to the LED Panel. The graphic design and intuitive menu guide the operator and service technician to all the functionality information, statistics and performances.

**Smart Top monitor 7" T**



Up to 16 languages available into the software. Top choice available for the range. Data statistics and crane management, all included into a 7" TFT monitor giving to the operator a higher level of awareness of the crane.

**Crane controls**

**Manual control** **M**



Crane with manual sequential controls have levers mounted on both sides of the crane. At each control station, the orientation of the controls can be the same up to down or left to right.

**LCD Remote control** **L**



Each transmitter is equipped with 8 ergonomic proportional levers (6 for Scanreco mini) to control up to 8 functions of the crane. Using two hands, the operator can move 2-3-4 functions at once. This ensure more speed in loading or unloading operations with high precision.

**Graphic remote control** **G**



Top visualization on 3" graphic display on the remote transmitter. Improved crane data visualization and crane control. Top level class of offer in the range.

**High-tech development**

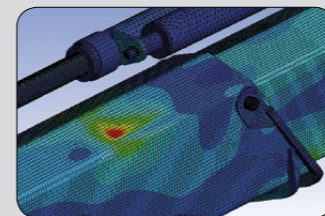

- Structures optimised for strength, weight and speed

**Top Protection**



- High value retention
- Top reliability

**Slewing Angle**

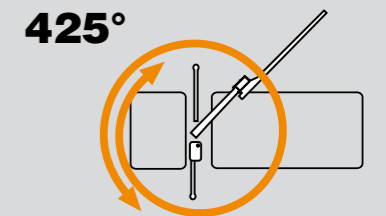

- Easy to start and close
- Save time
- Increased productivity and safety

**Functional Aesthetic**



Forged double linkages on column and 2nd boom



Hex Deck cover on base

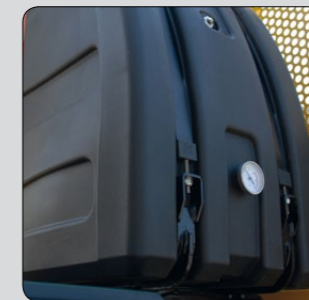

High volume oil tank made in sandwich-structured materials (PEX and PA6)



Robust column design and hoses cover



# 7103C *Technical data*

	Lifting Moment	Slewing Angle	Working pressure	Oil tank capacity	Max Oil flow	Max lifting height	Standard crane weight
	tm	°	bar	l	l/min	m	kg
A1	9,5	425	350	75	40	9,3	1215
A2	9,1	425	350	75	40	10,9	1305
A3	8,6	425	347	75	40	13,1	1395
A4	8,1	425	340	75	40	15,1	1480
A5	7,7	425	336	75	40	17,3	1555

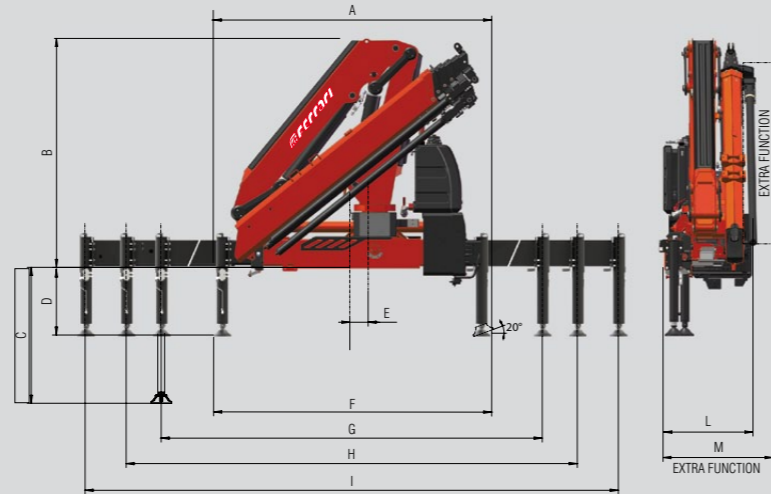

	A1	A2	A3	A4	A5
A	2290	2290	2290	2290	2290
B	2085	2085	2085	2085	2085
C	1185	1185	1185	1185	1185
D	530/585	530/585	530/585	530/585	530/585
E	160	160	160	160	160
F	2270	2270	2270	2270	2270
G	3290	3290	3290	3290	3290
H	4790	4790	4790	4790	4790
I	5755	5755	5755	5755	5755
L	800	800	800	800	845
M	845	845	845	845	910



RADIOCONTROL

## Standard

- Designed in accordance with EN12999+EN13849
- Design class: HC1-HD5
- Multifunctional radio remote control
- Sauer Danfoss PVG32
- P-PB Proportional Power Boost
- Flanged valves
- Oil tank
- Manually extendable stabilizers
- Fixed stabilizer cylinders
- Swivel stabilizer foot
- Centralized greasing system
- EQS Extension Quick System
- SDV Smooth Descent Valve
- Red Power
- A Class - Crane Control System (CE)
- LED panel - Human Machine Interface (CE)

**A1**

kg	9490*	4480°	2285	1600
m	1,00	2,00	4,12	5,93

**A2**

kg	9130*	4340°	2215	1530	1165	820	605
m	1,00	2,00	4,12	5,93	7,74	9,77	11,80

**A3**

kg	8630*	4100°	2055	1385	1035	815	610	430
m	1,00	2,00	4,20	6,01	7,82	9,77	11,80	13,95

**A4**

kg	8150*	3830°	1905	1255	915	705	580	425	355
m	1,00	2,00	4,28	6,09	7,90	9,85	11,80	13,95	16,13

**A5**

kg	7760*	3660°	1785	1155	830	625	500	415	330
m	1,00	2,00	4,35	6,16	7,97	9,92	11,87	13,95	16,13

\*) Theoretical lifting capacity  
 ⇒ Max lifting capacity

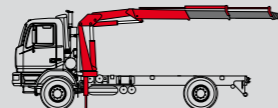

Recommended truck M.T.T. ton 12 - G.V.W. ton 12



## One model, many applications



Waste handling



Construction



Fence posts, poles and landscaping



With winch



**7103C**  
NEW AGE



ISO 9001 • ISO 14001

Quality and environmental certified



**F.lli FERRARI**

Via Einstein, 8  
42028 Poviglio (RE) Italy  
Tel. +39 0522/486308  
Fax +39 0522/486330  
info@flliferrari.it  
marketing@flliferrari.it  
www.flliferrari.com

Dealer

Data, descriptions, and illustrations pertain only and uniquely to models sold at the time of printing of this brochure. After the date of printing this information is purely indicative and not binding upon F.lli Ferrari. Future modifications are solely at the discretion of F.lli Ferrari and are always in compliance with applicable and pertinent safety standards. To obtain updated data, descriptions, and illustrations, contact the manufacturer or your reseller. Cranes manufactured and/or marketed by F.lli Ferrari.